

Super-Luminescent Light Emitting Diode (SLD)

TO CAN Packaged Devices



Features

- High power and broad band
- Low coherence length
- Uncooled & Cooled TO package
- Monitor PD is an option

Applications

- High Voltage & Current Monitor
- Optical Fiber sensor systems
- Optical communication

IPSDT1502 SLD TO CAN Specifications (T_{case}=25°C)

Parameter	Min.	Typ.	Max.	Unit	Test Condition
Central Wavelength	1520	1550	1570	nm	
3 dB Bandwidth	45	50	-	nm	
Output Power	2	3	-	mW	Flat Window Output
Operating Current	-	150	200	mA	
Forward Voltage	-	-	-	V	
Spectral Ripple	-	0.2	0.5	dB	
Beam Spread Angle:	-	-	-		
- Parallel	-	30	35	degree	
- Vertical	-	35	40	degree	

Detailed Information about operation/storage temperature available upon request: Contact sales@inphenix.com for more details

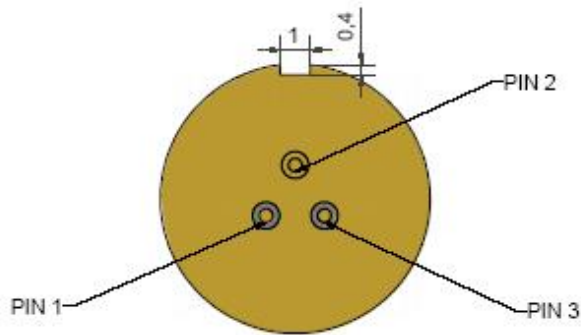

Pin#	Connection
1	SLD Anode
2	SLD Cathode, PD Cathode and Case
3	PD Anode

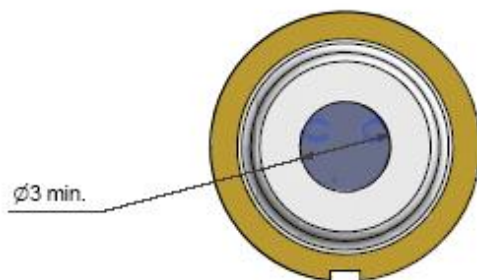
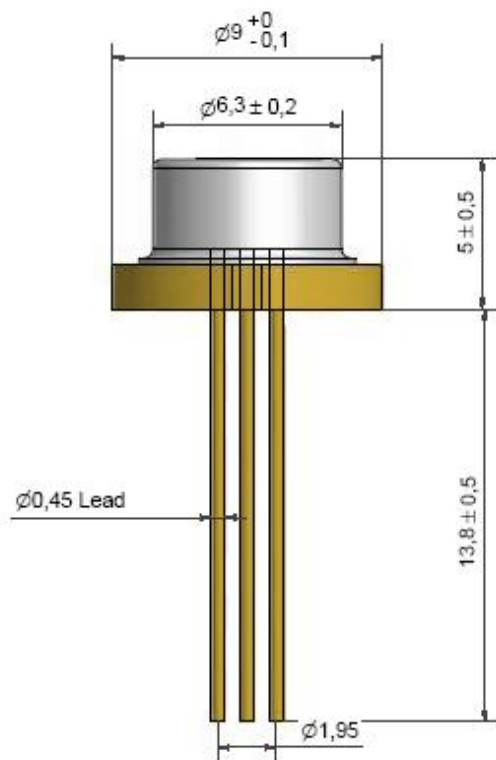

$\varnothing 9$ mm TO-CAN (TO5/TO9/TO39)

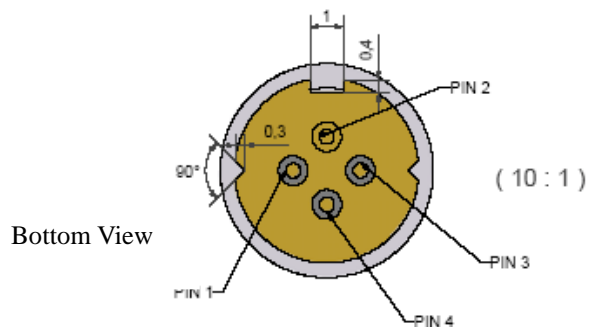

Pin#	Connection
1	PD Anode
2	SLD Cathode, PD Cathode and Case
3	SLD Anode
4	

Pigtail Information	
Connector	TBD
Fiber	SMF
Fiber Length	0.5 m

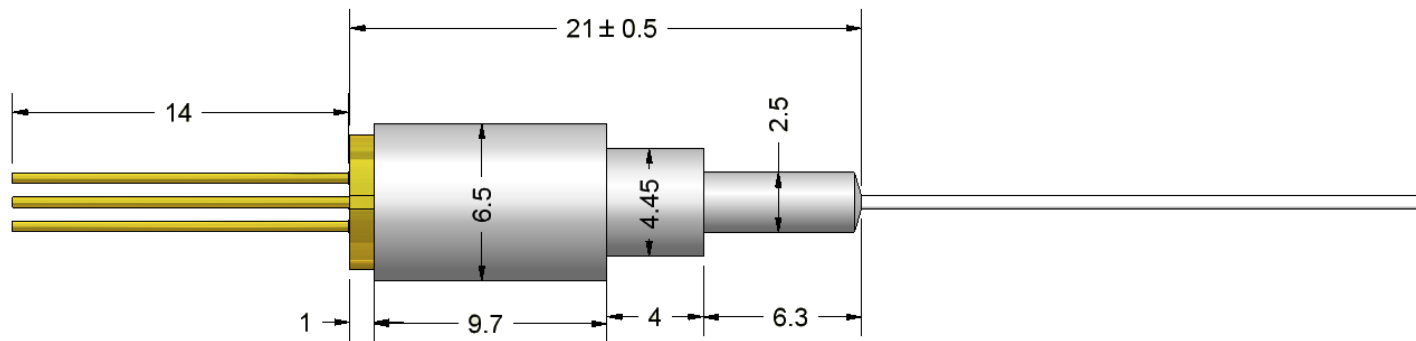

Unit: mm

φ5.6 mm Pigtailed Coaxial Device (TO56 Header)

Part Numbering System



Model-

- IPSDT0701: 750nm SLD TO CAN
- IPSDT080X: 820nm SLD TO CAN
- IPSDT090X: 900nm SLD TO CAN
- IPSDT13XX: 1310nm SLD TO CAN
- IPSDT150X: 1550nm SLD TO CAN

Package-

- 7: TO 56
- 8: TO 8
- 9: TO 9

Fiber Type:

- 0: No Cap 1: Single Mode 5: Ball Lens
- 6: Flat Glass 7: Aspheric Lens

Jacket Type:

- 0: No Jacket
- 1: 900 μ m
- 2: 250 μ m tight buffer

Connector Type:

- 0: No Connectors
- 3: FC/APC
- 4: FC/UPC
- 7: SC/APC
- 8: SC/UPC

Back Facet Monitor:

Available upon request

Example: IPSDT0801-9700: 820nm SLD, TO9 package with Aspheric lens.

Corporate Office

250 North Mines Rd
Livermore, CA 94551
Tel: 925.606.8809
Fax: 925.606.8810
www.inphenix.com
sales@inphenix.com